

Design and Development of Solar Pump System for Automatic Watering of Shallots

Muh. Ilham ^{1,a}, Yuliana ^{1,b}, Ahmad Rosyid Idris ^{1,2,c} Usman ^{1,2,*d}, and ^{1,2,e} Alamsyah Achmad

¹ Department Electrical Engineering, Politeknik Negeri Ujung Pandang, Perintis Kemerdekaan, KM. 10, Makassar, 90245, Indonesia.

² Center of Applied Electricity Energy System (CAEES), Electrical Building, 2nd Campus Politeknik Negeri Ujung Pandang, Moncongloe, Maros, 90562, Indonesia.)

^a ilham1718170170@gmail.com, ^b yulianataslim5@gmail.com, ^c ahmadrosyid@poliupg.ac.id, ^d usman.ose@poliupg.ac.id
^e alamsyahachmad@poliupg.ac.id



Abstract— Agriculture is a key sector of the Indonesian economy, with shallots being one of the most important commodities. However, limited access to electricity in rural areas is often a barrier to the implementation of efficient irrigation systems. This research focuses on developing an automatic shallot irrigation system using a solar pump. The system is designed by using solar panels to convert solar energy into electricity to power the water pump. They use an Arduino-based control system integrated with a real-time clock (RTC) to automatically set the watering schedule so that plants can be watered at the right time without human intervention. Tests were conducted on 96 m² of land to evaluate the performance of the automation system, energy efficiency, and system performance under actual operating conditions. The testing results show that the system can operate efficiently, with the solar panel generating enough energy to power the pump and maintain watering continuity. The system can reduce dependence on conventional electricity, providing a sustainable and environmentally friendly irrigation solution. As such, the system provides an effective solution for agricultural systems in areas with limited access to electricity, while supporting the use of renewable energy.

Keywords— solar energy; solar pump; automatic watering; shallots; Arduino

I. Introduction

In this section, author(s) should include the main reasons/background of selecting the research topic. Author(s) should also describe the literature review which containing other previous related research's outcomes including author(s) related previous research. The referencing method is exclusively following the IEEE referencing standard such as [1].

Agriculture plays a vital role in Indonesia's economy, especially in providing food and raw materials for industry. One of the main commodities produced by this sector is shallots, which are a staple ingredient in many Indonesian dishes. Given the rapid population growth rate, increasing market demand and high selling prices are factors that can stimulate farmers to be able to increase

agricultural production, especially in the case of shallots, which have become a commodity crop both in terms of quantity and quality, and increase the income of farmers [1]. However, shallot cultivation in Indonesia still faces various challenges, especially in terms of efficient irrigation. Adequate water availability and proper irrigation management determine the quality and quantity of shallot yields. Shallots are more sensitive to water stress during bulb formation and enlargement, which can result in unsatisfactory yield and quality [2].

However, a major problem that farmers often face is limited access to electricity in rural areas, which makes it difficult to use traditional water pumping systems for irrigation. The manual irrigation system that is still widely used is not only time-consuming and labor-intensive but also often inefficient in terms of water use, especially during the dry season. To overcome this availability of electrical energy, there is a need for innovation in renewable energy. One of the renewable energies available in nature that can be used as a source of electrical energy is sunlight [3].

The use of renewable technologies such as solar energy is a potential solution to this problem. Solar energy is an abundant source of energy because Indonesia is located in the equatorial region and will always be illuminated by the sun for 10-12 hours a day [4]. This energy can be used to power a water pumping system that works automatically. By using solar energy, this system is not only environmentally friendly but can also reduce dependence on conventional electricity.

Previous research that discusses solar pumps for agricultural needs has developed as in [1–3] used for

irrigation of rice fields, for corn mentioned in [4–6]. While solar water pumps used specifically for shallots are mentioned in [7,8]. Research [1,7] is implementing a battery-coupled type solar water pump with a submersible DC pump. Then in [2,4–6] a battery-coupled solar water pump is implemented with a submersible AC pump. Furthermore, in [3,8] a battery-coupled solar water pump is implemented with a surface AC pump. While research that discusses automatic watering includes [9,10] using a microcontroller and humidity sensor, [11,12] uses a microcontroller, RTC, and humidity sensor to turn the pump on and off. Also, [13] uses ESP32 and soil pH sensor, [14] uses NodeMCU ESP8266 and soil moisture sensor, [15] uses a microcontroller, DHT22 to turn the pump on and off. Next in [16] uses NodeMCU ESP8266, DHT11 and YL-69, [17] uses WEMOS D1R2 and YL-69, [18] uses Arduino Uno and RTC, [19] uses Raspberry Pi 3, DHT22 and YL-69 and [20] uses Arduino Uno and soil moisture sensor to turn on/off the pump.

According to the previous description, no research discusses the solar water pump system for the need for automatic watering of shallots. Therefore, the research designs a battery-coupled type solar water pump system using a surface DC pump with an automatic watering control system using Arduino Uno and RTC. The system has the potential to enhance the efficiency of irrigation practices and serve as a sustainable solution for farmers in regions with constrained access to electricity.

II. Research Methodology

A. Design of Solar Water Pump

The daily water requirement for the watering of shallots on a land area of ¼ ha is approximately 2.5 to 3 m³ [8]. The research will be conducted on a plot of land measuring 96 m², which will allow for the calculation of the daily water requirement, which is estimated to range from 1 to 1.2 m³. Assuming the pump can operate for 20 minutes/day. Then a pump with a discharge of 1.2 m³ is needed. According to the water discharge requirement by looking at the pump specifications available in the market, the pump power required is 180 W. To determine the capacity and number of solar panels needed to supply consecutive pumps, the following equation is used [8]

$$E_L = \frac{P \times h}{\eta_{PV} \times \eta_{bat}} \quad (1)$$

$$A_{PV} = \frac{E_L}{I_{ave} \times T_{CF}} \quad (2)$$

$$T_{CF} = \frac{P_{MPP}(0.5\% \times P_{MPP} \times \Delta t^\circ)}{P_{MPP}} \quad (3)$$

$$P_{PV,p} = A_{PV} \times PSI \times \eta_{PV} \quad (4)$$

$$nP_{PV} = \frac{A_{PV}}{P_{PV}} \quad (5)$$

where, E_L is the estimated daily energy demand (kWh/day), P is the power (kW), h is pump operating time (jam), A_{PV} s the solar panel area (m²). I_{ave} adalah is the solar insolation (kWh/m²/day), T_{CF} is the temperature correction factor, $P_{PV,p}$ is the maximum power generated by the solar panel (Wp), PSI is the peak solar radiation, η_{PV} is the solar panel efficiency (%), nP_{PV} is number of solar panels dan P_{PV} is the solar panel power per piece (Wp).

Determining the battery capacity and the number of batteries used can be calculated using [8]:

$$S_{BC} = \frac{N_C \times E_S}{DOD \times \eta_B} \quad (6)$$

$$S'_{BC} = \frac{1000 \times S_{BC}}{V_{DC,bus}} \quad (7)$$

$$N_B = \frac{S'_{BC}}{S'_{1,BC}} \quad (8)$$

where, S_{BC} battery capacity (kWh), DOD is deep of discharge (0.5-0,8), S'_{BC} is battery capacity (Ah), N_B is number of battery and $S'_{1,BC}$ is capacity of one battery (Ah).

By using a 100 Wp solar panel, based on equations (1)-(5), the solar panel requirement is 1 piece. While the number of batteries required using (6) - (8) is one piece with a capacity of 360Wh, the battery chosen is 30Ah 12V.

B. Hardware Architecture System

Hardware architecture system of automatic watering solar pump system shown in Figure 1. The solar pump system employs a monocrystal-type solar panel with a power rating of 100 Wp, a 30A PWM-type SCC, a 12 V 30 A VRLA battery, and a 12V 180 W surface DC pump. The automatic watering system is constructed with an Arduino Uno as the controlling device, receiving input from the real-time clock (RTC) to activate or deactivate the pump through a relay.

C. Software Design for Automatic Watering System

Software design for automatic watering system based on Figure 2. The flowchart is the basis for coding the program that will be embedded in the Arduino Uno.

D. Solar Pump Performance Parameters

The performance of solar pumps depends on the parameters of solar radiation at each location, PV efficiency, head, water flow, water requirement, and hydraulic power [21]. The efficiency of the solar panel, efficiency of pump, efficiency of and water discharge are determined by the following equation:

$$\eta_{pv} = \frac{E_{pv}}{A_{pv} \times E} \tag{9}$$

$$\eta_p = \frac{P_{out}}{P_{in}} \tag{10}$$

$$P_{input,p} = V \times I \tag{11}$$

$$P_{input,p} = m \times g \times h \tag{12}$$

Where, E_{pv} ; electrical energy generated by solar panel (Wh), A_{pv} ; surface area of solar panel (m^2), E ; solar radiation (W/m^2), V ; pump voltage (V), I ; pump current (A), m ; water mass flow rate (kg/s), g ; gravity (m/s^2), h ; head (m), η_p ; solar panel efficiency (%), η_{pv} ; pump efficiency (%), η_{sys} ; solar pump efficiency (%), η_{sys} ; solar pump system efficiency (%).

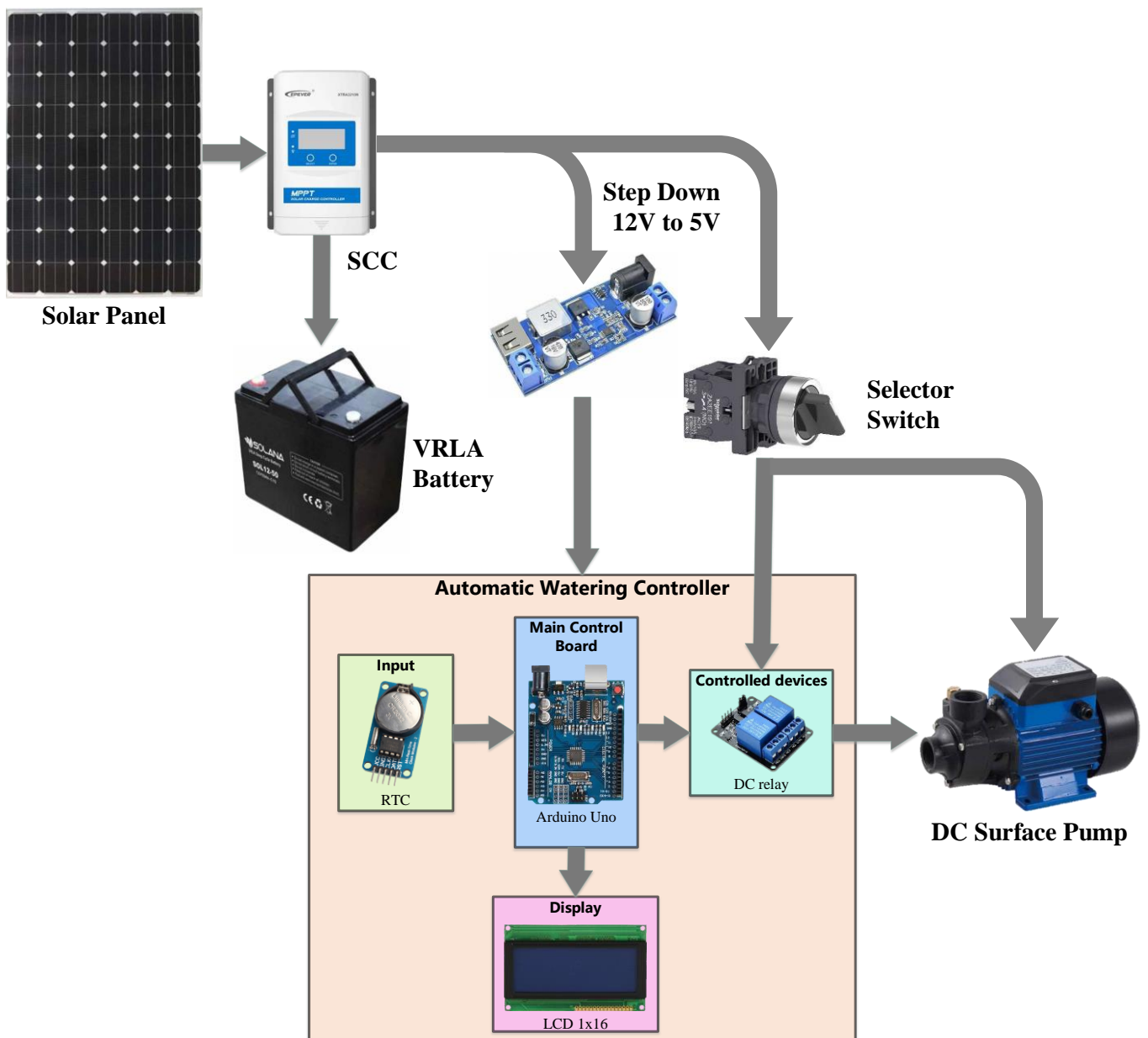

Figure 1. Hardware architecture system of automatic watering solar pump system.

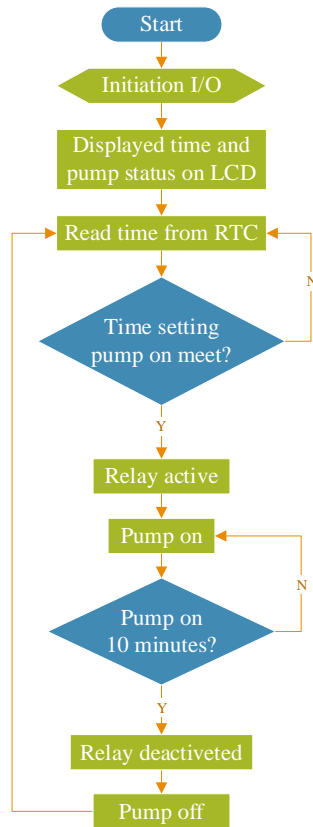

Figure 2. Software design for automatic watering system.

E. Automatic Watering System Performance Analisis

An analysis is conducted to evaluate the effectiveness of the automatic watering system. The watering system is set to operate automatically for 10 minutes every 7:00 AM and 5:00 PM every day. The purpose of this test is to ensure that the pump and control system can work according to a predetermined schedule. The method used in this test is black box testing. Black box testing is a testing technique that focuses on the output results of the program by providing input values and determining errors through five parameters, namely function, interface, data structure, performance as well as initialization and termination.

F. Experimental Setup

The experimental setup of the solar pump performance testing is shown in Figure 3. This performance test is to determine the efficiency of the solar pump. The measured data are solar irradiation, solar panel current, solar panel voltage, solar panel power, solar panel energy, battery capacity (battery percentage), pump current, pump voltage, pump power, energy, and pump discharge.

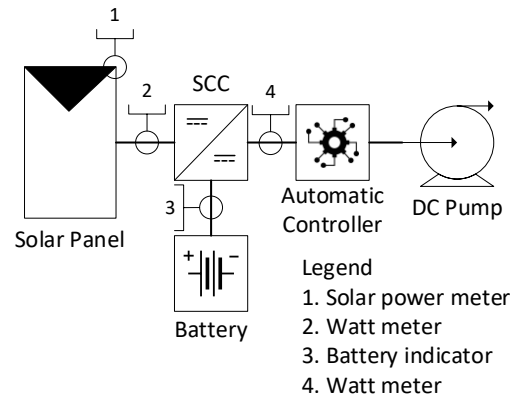
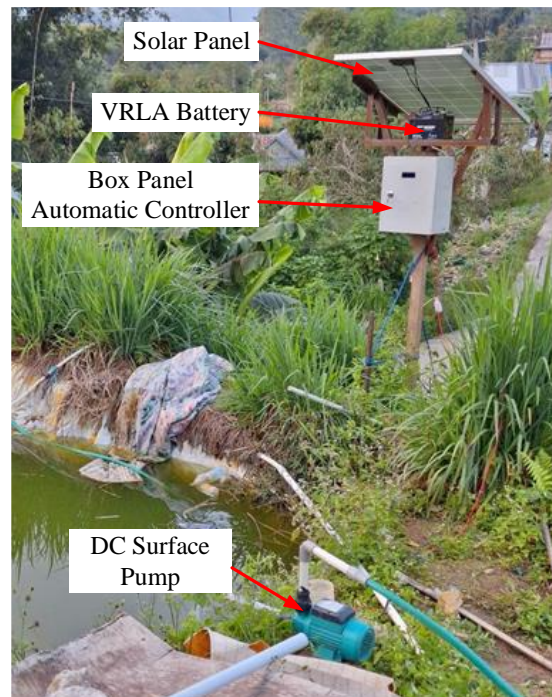

Figure 3. Experimental setup of the solar pump performance testing.

III. Results and Discussion

The solar pump for shallots uses a 100 Wp solar panel to supply power to a 30 Ah battery, and a 180 W DC pump. The water source for watering is pumped from a reservoir and channeled to 6 sprinklers to water 96 m² of land. The implementation results are presented in Figure 4.

The results of testing the automatic solar water pump system using the black box method are presented in Table 1. Based on the table, all test scenarios can work as expected. The pump is on and off according to the predetermined settings and lasts 10 minutes, every 7:00 AM and 5:00 AM.



(a)

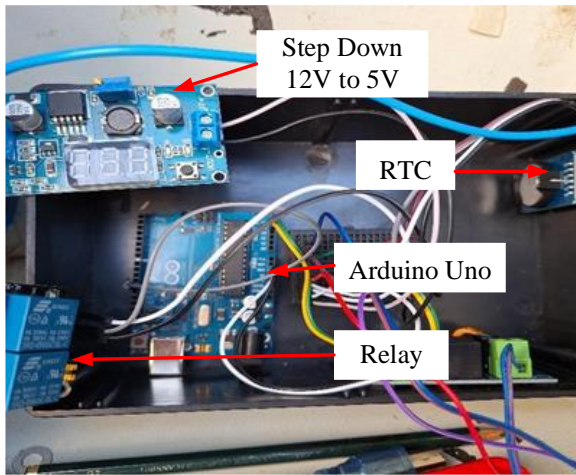

(b)

Figure 4. Implementation of automatic watering solar pump system, (a) solar pump system and (b) automatic control system.

Figure 5 shows the battery capacity before and after the watering process. During the 7-day test, the average battery capacity was reduced by 8% for morning watering. While in the afternoon it was 12.29%. Each pump on uses an average energy of 18.89 Wh in the morning and 19.96 Wh in the afternoon. So, every day the solar pump uses an average of 38.85 Wh.

The pump efficiency (%) is shown in Figure 6. The implemented power pump system has an average efficiency of 38.06% in the morning and 36.41% in the afternoon. Based on references [21], the efficiency of solar pump ranges from 30% - 70%. The input power of the pump (W) is inversely proportional to the efficiency achieved by the pump. The higher the power used by the pump, the lower the efficiency. According to [22], increasing the input power to a pump can significantly increase the pump's workload and simultaneously

decrease its efficiency. As a result, pumps operating at higher input power tend to have lower net output and reduced efficiency.

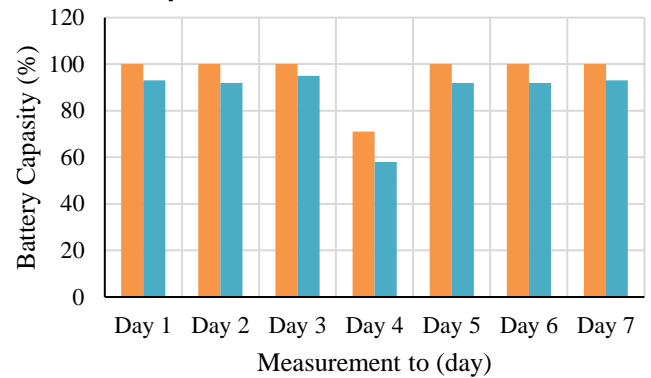

Before Watering (%) After Watering (%)

(a)

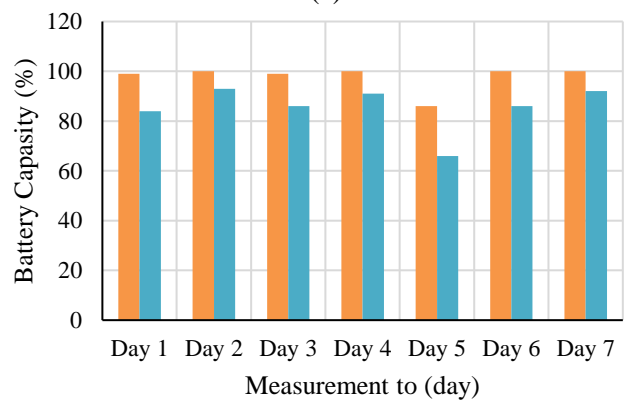

Before Watering (%) After Watering (%)

(b)

Figure 5. Battery capacity before watering and after watering, (a) morning (7:00 AM) dan (b) afternoon (5:00 AM).

Table 1. Blackbox automatic watering testing result.

Test Item	Expected Result	Actual Result	Conclusion
Timing by RTC	The RTC provides accurate time to the Arduino to set the pump operation schedule according to the specified time, the pump operates at 7:00 AM - 7:10 AM and 5:00 AM - 5:10 AM	The time from the RTC is accurate and on schedule	Success
Pump on based on schedule	When the Arduino receives the time from the RTC and signals HIGH to the relay, it causes the NO contact to close so that current flows from the battery to the pump, and the pump operates	The pump operates when the Arduino sends a HIGH signal to the relay based on the time received from the RTC.	Success
Pump off based on schedule	When the Arduino receives the time from the RTC to give a LOW signal to the relay, the relay returns to the open state so that the circuit is not connected and the current does not flow to the pump so that the pump does not operate	The pump does not operate when the Arduino sends a LOW signal to the relay based on the time received from the RTC	Success

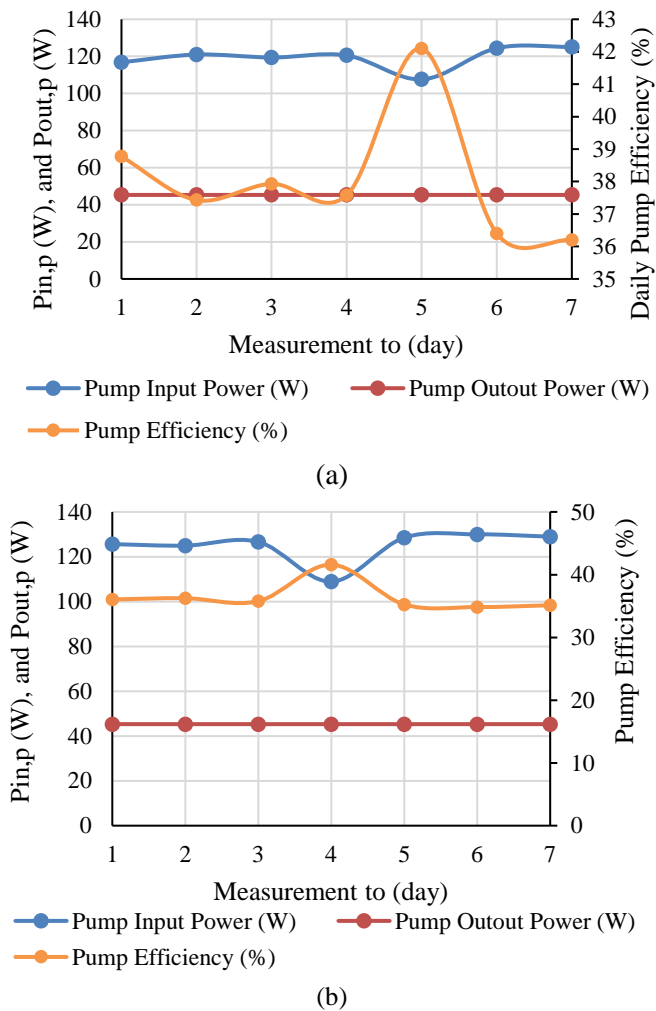

Figure 6. Input power, output power and pump efficiency, (a) morning, and (b) afternoon.

iv. Conclusion

The implemented solar pump system has worked automatically well. This solar pump can work for 10 minutes every 7am and 5pm. Every day the pump uses 38.78 Wh of energy. The average efficiency of the pump is 38.06% in the morning and 36.41%. This solar pump can optimize watering time, making the process more efficient and effective in terms of both time and energy.

Acknowledgement

We express our gratitude to The State Polytechnic of Ujung Pandang for their generous financial support under Grant No. 798/P/2024 which made this research possible.

References

[1] Sinaga HH, Permata D, Soedjarwanto N, Purwasih N. Pompa Air Tenaga Surya untuk Irigasi Persawahan bagi Masyarakat Desa Karang Rejo, Pesawaran, Lampung. Wikrama Parahita : Jurnal

Pengabdian Masyarakat 2021;5:22–6. <https://doi.org/10.30656/jpmwp.v5i1.2633>.

[2] Purboseno S, Supriyanto G, Margono B. Rancang Bangun Irigasi Air Tanah Dangkal Dengan Pompa Tenaga Surya di Desa Umbulrejo Kecamatan Ponjong Kabupaten Gunung Kidul DIY. PROSIDING SEMINAR NASIONAL INSTIPER 2022;1:195–204. <https://doi.org/10.55180/pro.v1i1.255>.

[3] Hoetama I, Yasar M, Bulan R. Uji Kinerja Pompa Air Tenaga Surya Untuk Irigasi. Jurnal Ilmiah Mahasiswa Pertanian 2019;4:85–94. <https://doi.org/10.17969/jimfp.v4i3.11492>.

[4] Lastriyanto A, Wilujeng MUP. Sistem Irigasi Tanaman Jagung dengan Pompa Submersible Tenaga Surya si Desa Anaenge Sumba Barat Daya. Prosiding Seminar Nasional Penelitian & Pengabdian Kepada Masyarakat 2022, Makassar, Indonesia: P3M Politeknik Negeri Ujung Pandang; 2022, p. 128–30.

[5] Haddada J, Tarakka R, Rahman AN, Mochtar AA, Arief S. Aplikasi Pompa Air Tenaga Matahari untuk Petani Palawija di Kabupaten Takalar. JURNAL TEPAT : Applied Technology Journal for Community Engagement and Services 2018;1:147–54. https://doi.org/10.25042/jurnal_tepat.v1i2.35.

[6] Darmawan FA, Aqsha I, Hambali A. Penerapan Teknologi Pompa Irigasi Sawah berbasis Tenaga Surya di Desa Paramambe Kabupaten Takalar Sulawesi Selatan. SEMAR (Jurnal Ilmu Pengetahuan, Teknologi, Dan Seni Bagi Masyarakat) 2023;12:54. <https://doi.org/10.20961/semar.v12i1.65873>.

[7] Widodo P, Nasution DA. Rekayasa Disain Pompa Tenaga Surya untuk Irigasi BudidayaBawang Merah di Lahan Kering. Prosiding Seminar Nasional Pengembangan Teknologi Pertanian, Lampung, Indonesia: Politeknik Negeri Lampung; 2016, p. 292–9. <https://doi.org/10.25181/prosemnas.v0i0.492>.

[8] Usman U, Utomo MNY, Achmad A, Sofyan S, Ramadhan A, Ramadhan F, et al. Implementasi Sistem Pompa Air Tenaga Surya Tipe Battery Coupled dan Website Pemasaran pada Kelompok Tani Pakkoko Ka'jung. Jurnal Abdi Insani 2023;10:2072–86. <https://doi.org/10.29303/abdiinsani.v10i4.1134>.

[9] Fajriyah RE, Faiza D. Rancang Bangun Sistem Kontrol dan Monitoring Penyiraman Tanaman Cabai Otomatis Berbasis Internet of Things. Voteteknika (Vocational Teknik Elektronika Dan Informatika) 2024;12:26. <https://doi.org/10.24036/voteteknika.v12i1.125663>.

[10] Gunanto S, Wibowo A. Monitor & Kontrol Penyiraman Tanaman Otomatis Berbasis IoT. Journal Computer Science and Informatic Systems:J-Cosys 2024;4:1–8. <https://doi.org/https://doi.org/10.53514/jco.v4i2.498.g305>.

[11] Fatkhul Yaqin MB, Rintyarna BS, Setyawan H. Rancang Bangun Prototipe Smart Greenhouse Berbasis IoT Untuk Mengontrol Pertumbuhan Tanaman Bawang Merah (Allium Ascalonicum L). Jurnal Teknik Elektro Dan Komputasi (ELKOM) 2024;6:112–24. <https://doi.org/10.32528/elkom.v6i1.20697>.

[12] Rajagukguk A, Simamora JF, Ervianto E. Rancang Bangun Pengendali Sistem Pompa Otomatis Pada Penyiraman Tanaman Berbasis Sensor Kelembaban dengan Kendali Arduino. PROtek : Jurnal Ilmiah Teknik Elektro 2021;8:76–82. <https://doi.org/10.33387/protk.v8i2.3122>.

[13] Sari IV, Darmayanti DR, Widiyanti C, Indani W, Sitopu MW. Sistem Otomatis Penyiraman dan Pemupukan Tanaman Tin Menggunakan Mikrokontroler ESP32. Jurnal Informatika Dan Teknik Elektro Terapan 2024;12:1997–2003.

- <https://doi.org/10.23960/jitet.v12i3.4564>.
- [14] Muhammad Chanafi, Sudarmana L, Syahrudin F. Rancang Bangun Sistem Penyiraman Otomatis Menggunakan Sensor Kelembaban Tanah pada Tanaman Seledri Berbasis NODEMCU ESP8266. *Teknomatika: Jurnal Informatika Dan Komputer* 2023;13:52–62. <https://doi.org/10.30989/teknomatika.v13i2.1136>.
- [15] Nurrahmi S, Miseldi N, Syamsu SH. Rancang Bangun Sistem Penyiraman Otomatis pada Green House Tanaman Anggrek Menggunakan Sensor DHT22. *JPF (Jurnal Pendidikan Fisika) Universitas Islam Negeri Alauddin Makassar* 2023;11:33–43. <https://doi.org/10.24252/jpf.v11i1.33419>.
- [16] Winarno A, Rochman S, Thoyibin M. Rancang Bangun Sistem Otomatisasi Penyiraman Tanaman Tomat Berbasis Internet of Things. *Voteteknika (Vocational Teknik Elektronika Dan Informatika)* 2023;11:473–80. <https://doi.org/10.24036/voteteknika.v11i4.126124>.
- [17] Alamsyah N. Rancang Bangun Penyiraman Bibit Tanaman Secara Otomatis Menggunakan WEMOS D1 R2. *Nuansa Informatika* 2022;16:108–15. <https://doi.org/10.25134/nuansa.v16i1.5179>.
- [18] Alfianugraha K. Rancang Bangun Alat Penyiraman Tanaman Tomat Otomatis Menggunakan Sensor Rtc Berbasis Arduino Uno. *COMSERVA Indonesian Journal of Community Services and Development* 2022;2:369–83. <https://doi.org/10.59141/comserva.v2i5.317>.
- [19] Zikri A, Yuniarti E, Lestari D. Rancang Bangun Sistem Penyiraman Tanaman Otomatis Berbasis Raspberry Pi 3 dengan Memanfaatkan Thingspeak dan Interface Android Sebagai Kendali. *Jurnal Fisika Unand* 2022;11:44–9. <https://doi.org/10.25077/jfu.11.1.44-49.2022>.
- [20] Putri ID, Sukardi S. Rancang Bangun Alat Penyiram Tanaman Hias Otomatis Berdasarkan Kelembaban Berbasis Mikrokontroler. *JTEIN: Jurnal Teknik Elektro Indonesia* 2022;3:74–83. <https://doi.org/10.24036/jtein.v3i1.210>.
- [21] Usman U, Sunding A, Parawangsa AN. Performance and Economic Analysis of Solar Water Pump System Laboratory Scale. *JTT (Jurnal Teknologi Terapan)* 2018;4:8–12. <https://doi.org/10.31884/jtt.v4i1.96>.
- [22] Al-Shemmeri TT. Thermodynamics, performance analysis and computational modelling of small and micro combined heat and power (CHP) systems. *Small and Micro Combined Heat and Power (CHP) Systems*, Elsevier; 2011, p. 42–69. <https://doi.org/10.1533/9780857092755.1.42>.